

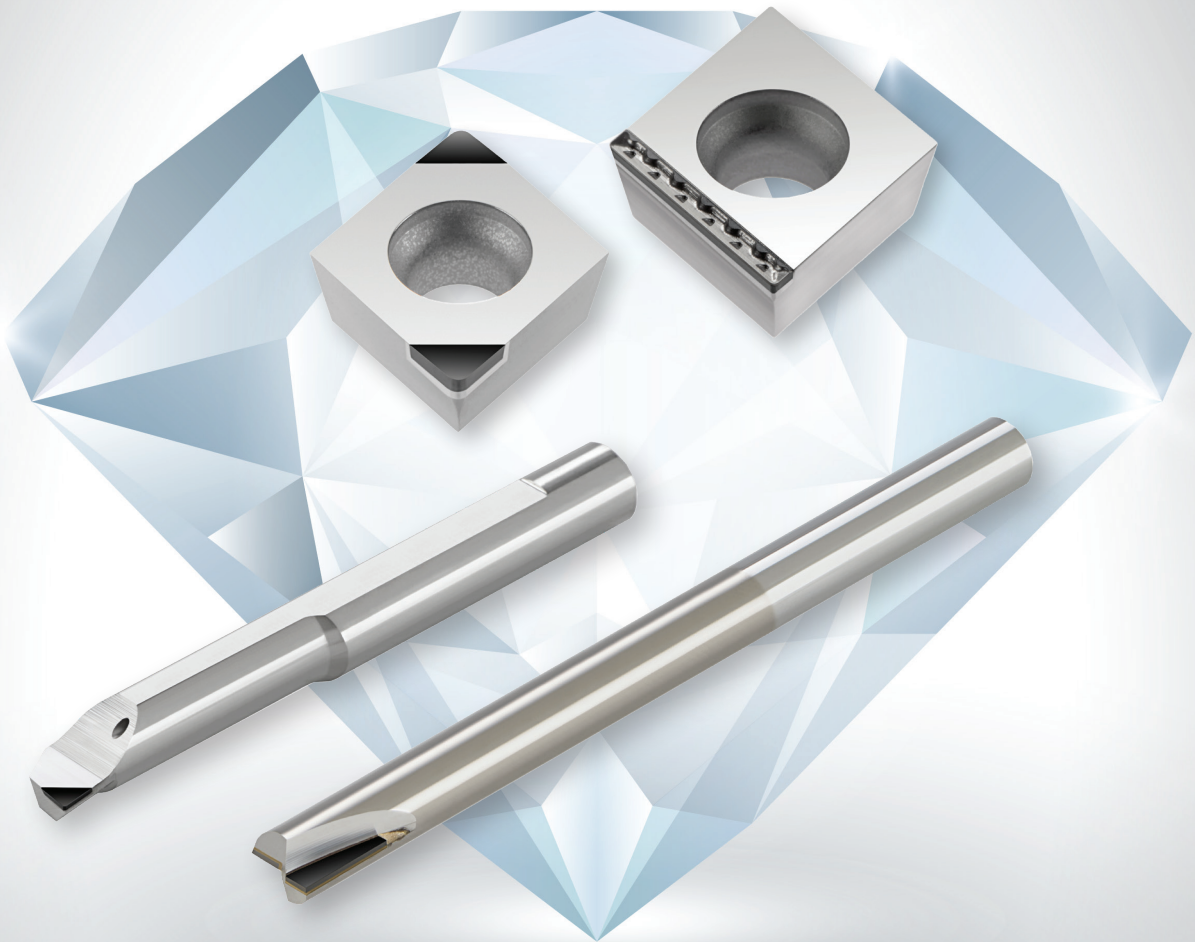

Diamond Tools



Metric

Carmex Diamond Tools

Carmex PCD, CVD-T and PCBN cutting tools are designed for high productivity and longer tool life when machining materials ranging from plastics to brass, cast iron, hardened steel, and super alloys. The inserts provide faster machining times compared to grinding and outperform ceramics, thereby reducing production costs.



PCD

PCD is a composition of diamond particles sintered together with a metallic binder. The polycrystalline structure creates a hard and wear-resistant tool with high thermal conductivity to quickly transfer heat away from the cutting edge. Since diamond is the hardest material available, it provides the highest abrasive resistance. PCD tools are used for non-ferrous materials, high-silicon aluminum, carbon fiber, and plastic (CFRP).

CVD

The CVD cutting material is harder than PCD and twice as wear-resistant. CVD delivers various benefits when machining long-chipping aluminum and magnesium alloys, high-silicon aluminum, precious metal alloys, plastics with abrasive fillers, tungsten carbide, and ceramic green compacts. Laser equipment is used to cut out the segments from the CVD-thick film. These are then attached to inserts by brazing under vacuum. The chip breakers and cutting edges are also laser formed. The advanced chip breaker reduces contact of the chip with the insert surface, which considerably reduces heat generation and energy consumption. In addition, the controlled chip breaker increases process reliability and reduces cutting forces.

PCBN

Its high heat resistance combined with the high level of hardness, which is second only to diamond, makes PCBN the ideal cutting material for machining hardened steels. In addition to the machining of hardened steels (45-72 HRC), this cutting material group is also highly suited to the machining of cast materials and special alloys—applications in which carbide and cutting ceramic tools often reach their limits. CBN material provides excellent heat resistance and can be used at very high cutting speeds. It also enhances toughness and thermal shock resistance.

Contents:	Page:
ISO codes	6-7
PCD and CVD Thick film diamond inserts	
Positive 80° CCGT – single cutting edge	8
Positive 80° CCGT – GS, single cutting edge	8
CCGW 80° – single cutting edge	9
CCGW 80° – GS, single cutting edge	10
CDGW 80° – two cutting edges	10
Positive 80° CPGT – single cutting edge	11
CPGW 80° – single cutting edge	11
Positive 55° DCGT – single cutting edge	12
DCGW 55° – single cutting edge	13
RCGW – Full Face	14
Positive 60° TCGT – single cutting edge	14
Positive 60° TCGT – GS	15
TCGW 60° – single cutting edges	16
TCGW 60° – GS	16
TPGW 60° – single cutting edge	17
Positive 35° VCGT – single cutting edge	17
VCGW 35° – single cutting edge	18
WCGW 80° – three cutting edges	18

PCBN inserts

Neutral 80° CCGW – two cutting edges	19
Neutral 80° CDGW – two cutting edges	20
Neutral 80° CNGA – two cutting edges	20
Neutral 55° DCGW – two cutting edges	21
Neutral 55° DNGA – two cutting edges	22
Neutral RCGW	22
Neutral 60° TCGW – three cutting edges	23
Neutral 60° TNGA – three cutting edges	23
Neutral 60° TPGW – one cutting edge	24
Neutral 35° VCGW – two cutting edges	24
Neutral 35° VNGA – two cutting edges	25
Neutral 80° WCGW – three cutting edges	25
Neutral 80° WNGA – three cutting edges	26
Wiper geometry	27
Material type comparison	27
Technical information (CVD, PCD, CBN inserts)	28-30
Case studies CVD, PCD, CBN	31
Carbide shank turning toolholders	32-35
Tiny tools with diamond cutting edge	36-39
Diamond end mills	40-43

ISO Codes

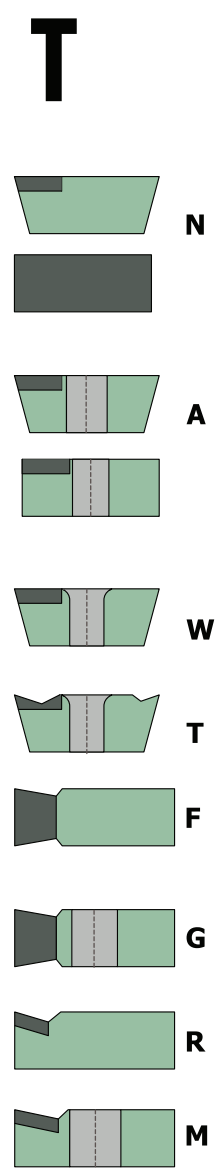
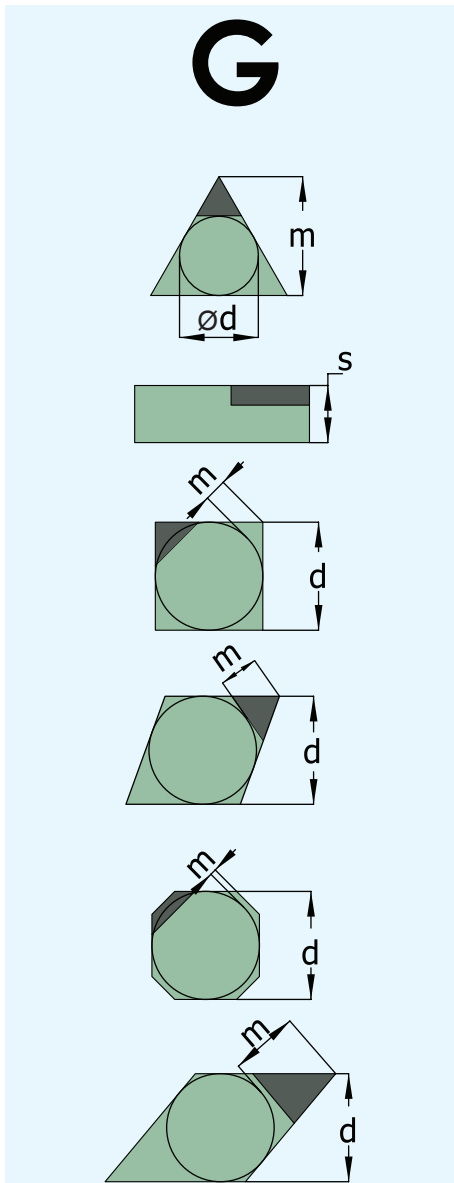
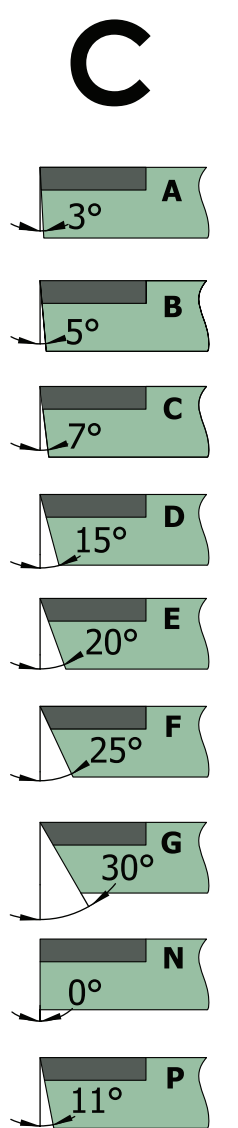
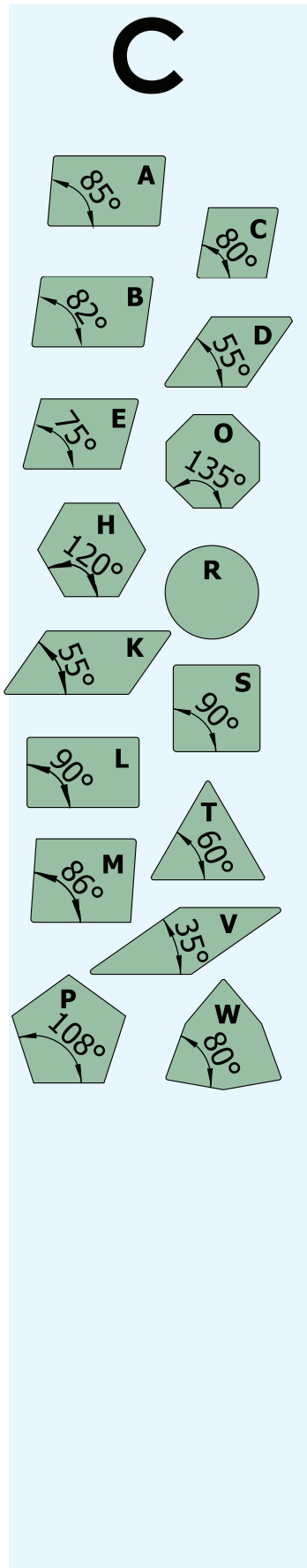

	m	s	d
A	±0.005	±0.025	±0.025
F	±0.005	±0.025	±0.013
C	±0.013	±0.025	±0.025
H	±0.013	±0.025	±0.013
E	±0.025	±0.025	±0.025
G	±0.025	±0.130	±0.025
	m	s	d
J	±0.005	±0.025	±0.05 -> ± 0.15
K	±0.013	±0.025	±0.05 -> ± 0.15
L	±0.025	±0.025	±0.05 -> ± 0.15
M*	±0.08 -> ± 0.20	±0.130	±0.05 -> ± 0.15
N*	±0.08 -> ± 0.20	±0.250	±0.05 -> ± 0.15
U*	±0.13 -> ± 0.38	±0.130	±0.08 -> ± 0.15

11

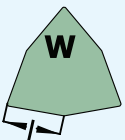
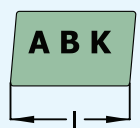
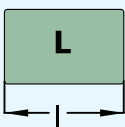
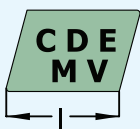
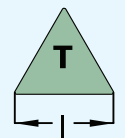
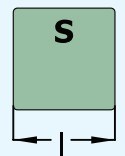
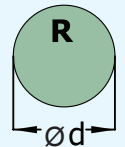
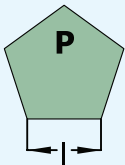
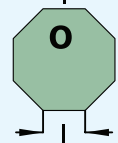
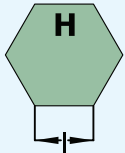

x - special

06

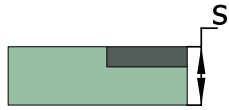

	S
01	1.59
T1	1.98
02	2.38
03	3.18
T3	3.97
04	4.76
05	5.56
06	6.35

02

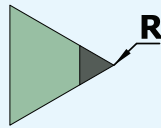

01	0.1
02	0.2
04	0.4
08	0.8
12	1.2
16	1.6

00 = round insert / inch

M0 = round insert / metric

R/L GS W PCD

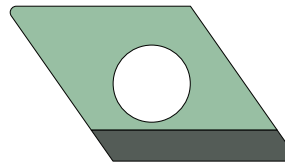
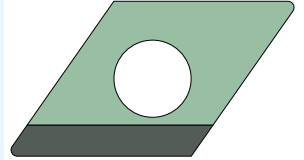

**CVD
PCD
CBN**

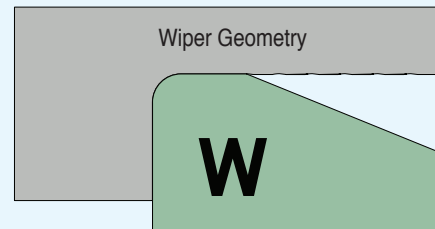
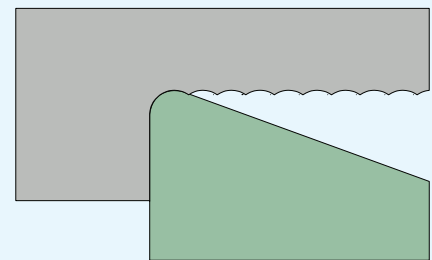

PCD and CVD Thick film diamond

Positive 80° - CCGT – single cutting edge

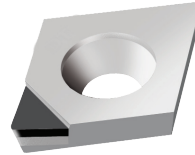
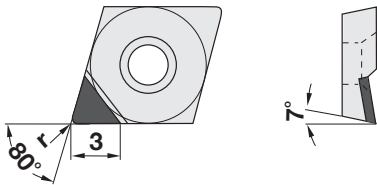

Ordering Code	Toolholder
CCGT 060202	SCLC...06 A/E...SCLC.06
CCGT 060204	
CCGT 060208	
CCGT 09T302	SCLC...09 A/E...SCLC.09
CCGT 09T304	
CCGT 09T308	
CCGT 09T312	SCLC...12 A/E...SCLC.12
CCGT 120402	
CCGT 120404	
CCGT 120408	

ISO Standard	Type	Grade
N	Positive	PCD
		CVD

Order example: CCGT 060202 **PCD** or
CCGT 060202 **CVD**

Positive 80° - CCGT – GS, single cutting edge

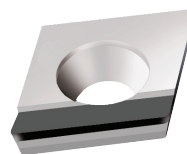
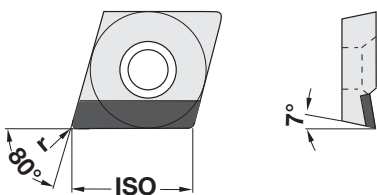

Ordering Code	Toolholder
CCGT 060202 R/L-GS	SCLCR/L...06 A...SCLCR/L.06
CCGT 060204 R/L-GS	
CCGT 060208 R/L-GS	
CCGT 09T304 R/L-GS	SCLCR/L...09 A...SCLCR/L.09
CCGT 09T308 R/L-GS	
CCGT 09T312 R/L-GS	

ISO Standard	Type	Grade
N	Positive	PCD
		CVD

Order example: CCGT 060204 R-GS **PCD** or
CCGT 060204 R-GS **CVD**
For L.H, specify CCGT 060204 **L...** instead of
CCGT 060204 **R...**

CCGW 80°-single cutting edge

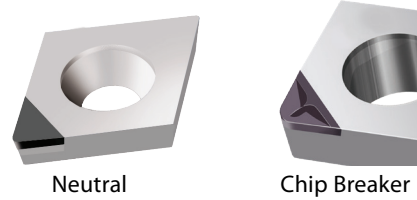
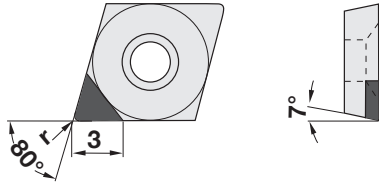

Ordering Code	Toolholder
*CCGW 060201	SCLC...06 A...SCLC.06
CCGW 060202	
CCGW 060204	
CCGW 060208	
CCGW 09T302	SCLC...09 A...SCLC.09
CCGW 09T304	
CCGW 09T308	
CCGW 09T312	
CCGW 120402	SCLC...12 A...SCLC.12
CCGW 120404	
CCGW 120408	
CCGW 120412	

ISO Standard	Type	Grade
N	Neutral	PCD
	F - Chip Breaker	
	R - Chip Breaker	
	Neutral	CVD
	F - Chip Breaker	
	R - Chip Breaker	

F - Finishing R - Roughing

Order example: CCGW 060202 **N PCD** or
CCGW 060201 **R CVD**

* Available only in **Neutral CVD** grade

Wiper

Ordering Code	Toolholder
CCGW 060202-W	SCLC...06 A...SCLC.06
CCGW 060204-W	
CCGW 09T302-W	SCLC...09 A...SCLC.09
CCGW 09T304-W	
CCGW 09T308-W	
CCGW 120402-W	SCLC...12 A...SCLC.12
CCGW 120404-W	
CCGW 120408-W	

Order example: CCGW 120402-W**F PCD** or
CCGW 120402-W**R CVD**
Same insert for R.H or L.H cutting

CCGW 80° – GS, single cutting edge

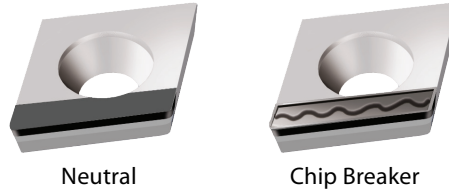
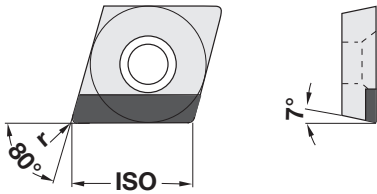

Ordering Code	Toolholder
CCGW 060202 R/L-GS	SCLCR/L...06 A...SCLCR/L.06
CCGW 060204 R/L-GS	
CCGW 060208 R/L-GS	
CCGW 09T304 R/L-GS	SCLCR/L...09 A...SCLCR/L.09
CCGW 09T308 R/L-GS	
CCGW 09T312 R/L-GS	

ISO Standard	Type	Grade
N	Neutral	PCD
	F - Chip Breaker	
	R - Chip Breaker	
	Neutral	CVD
	F - Chip Breaker	
	R - Chip Breaker	

Order example: CCGW 09T304 R-GSF **PCD** or
CCGW 060202 R-GSN **CVD**
For L.H, specify CCGW 09T304 **L...** instead of
CCGW 09T304 **R...**

F - Finishing R - Roughing

CDGW 80° – two cutting edges

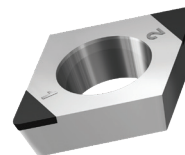
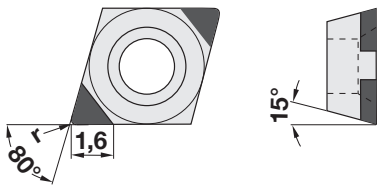

Ordering Code	Toolholder
CDGW 040101	E...SCLDR/L 04
CDGW 040102	
CDGW 040104	

ISO Standard	Type	Grade
N	Neutral	CVD

Order example: CDGW 040102 **CVD**

Positive 80° - CPGT – single cutting edge

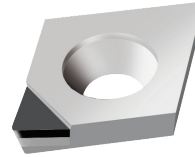
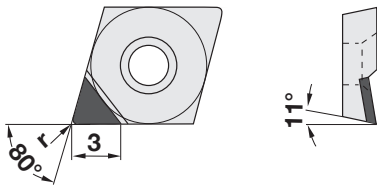

Ordering Code	Toolholder
CPGT 060202	SCLP...06 A...SCUP.06
CPGT 060204	
CPGT 060208	

ISO Standard	Type	Grade
N	Positive	PCD
		CVD

Order example: CPGT 060202 **PCD** or
CPGT 060202 **CVD**

CPGW 80° – single cutting edge

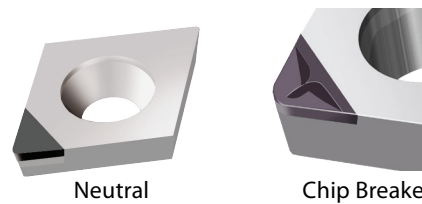

Ordering Code	Toolholder
*CPGW 060201	SCLP...06 A...SCUP.06
CPGW 060202	
CPGW 060204	
CPGW 060208	
*CPGW 09T301	SCLP...09 A...SCUP.09
CPGW 09T302	
CPGW 09T304	
CPGW 09T308	

ISO Standard	Type	Grade
N	Neutral	PCD
	F - Chip Breaker	
	R - Chip Breaker	
	Neutral	CVD
	F - Chip Breaker	
	R - Chip Breaker	

F - Finishing R - Roughing

Order example: CPGW 060201 **N PCD** or
CPGW 060201 **R CVD**

* Available only in **Neutral CVD** grade

Positive 55° - DCGT – single cutting edge

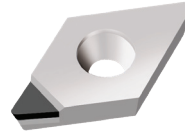
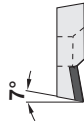
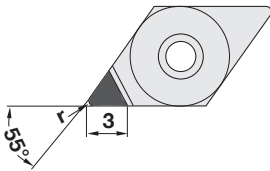

Ordering Code	Toolholder
DCGT 070201	SDJC..07 A...SDUC./ A/E...SDQC.07
DCGT 070202	
DCGT 070204	
DCGT 070208	
DCGT 11T301	SDJC..11 A...SDUC./ A/E...SDQC.11
DCGT 11T302	
DCGT 11T304	
DCGT 11T308	
DCGT 11T312	

ISO Standard	Type	Grade
N	Positive	PCD
		CVD

Order example: DCGT 070201 **PCD** or
DCGT 070201 **CVD**

Wiper

Ordering Code	Toolholder
DCGT 070202-W	SDJC..07 A...SDUC.07
DCGT 070204-W	
DCGT 070208-W	
DCGT 11T302-W	SDJC..11 A...SDUC.11
DCGT 11T304-W	
DCGT 11T308-W	

Order example: DCGT 11T302-W **PCD** or
DCGT 11T302-W **CVD**
Same insert for R.H or L.H cutting

DCGW 55° – Single cutting edge

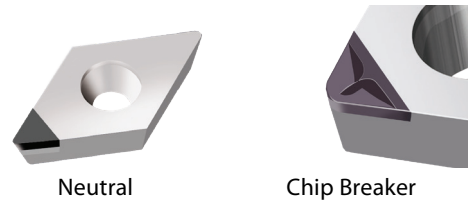
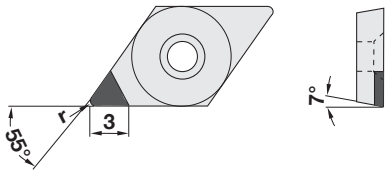

Ordering Code	Toolholder
*DCGW 070201	SDJC..07 A...SDUC./ A/E...SDQC.07
DCGW 070202	
DCGW 070204	
DCGW 070208	
*DCGW 11T301	SDJC..11 A...SDUC./ A/E...SDQC.11
DCGW 11T302	
DCGW 11T304	
DCGW 11T308	
DCGW 11T312	

ISO Standard	Type	Grade
N	Neutral	PCD
	F - Chip Breaker	
	R - Chip Breaker	
	Neutral	CVD
	F - Chip Breaker	
	R - Chip Breaker	

F - Finishing R - Roughing

Order example: DCGW 11T312 **F PCD** or

DCGW 11T312 **F CVD**

* Available only in **Neutral PCD/CVD** grade

Wiper

Ordering Code	Toolholder
DCGW 070202-W	SDJC..07 A...SDUC.07
DCGW 070204-W	
DCGW 070208-W	
DCGW 11T302-W	SDJC..11 A... SDUC.11
DCGW 11T304-W	
DCGW 11T308-W	

Order example: DCGW 070208-**WR PCD** or

DCGW 070208-**WR CVD**

Same insert for R.H or L.H cutting

RCGW – Full Face

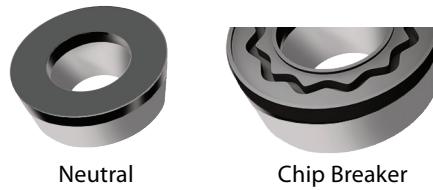
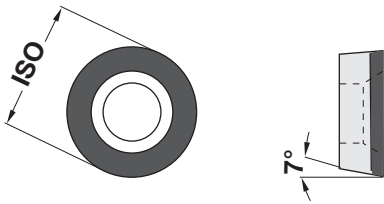

Ordering Code	Toolholder
RCGW 0602 M0-FF	SRDCN/ SRGC...06 E...SRLC.06
RCGW 0803 M0-FF	SRDCN./ SRGC...08
RCGW 1003 M0-FF	SRDCN./ SRGC...1003 E...SRLC.1003
RCGW 10T3 M0-FF	SRDCN./SRGC... 10T3
RCGW 1204 M0-FF	SRDCN./ SRGC...12

ISO Standard	Type	Grade
N	Neutral	PCD
	F - Chip Breaker	
	R - Chip Breaker	
	Neutral	CVD
	F - Chip Breaker	
	R - Chip Breaker	

F - Finishing R - Roughing

Order example: RCGW 0602 M0-FFR **PCD** or
RCGW 0602 M0-FFN **CVD**

Positive 60° - TCGT - Single cutting edge

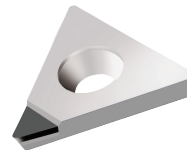
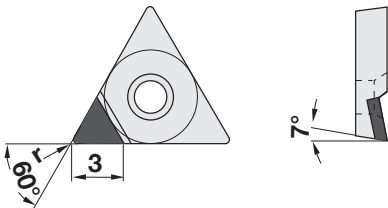

Ordering Code	Toolholder
TCGT 090202	STGC...09 A...STFC.09
TCGT 090204	
TCGT 090208	
TCGT 110202	E10M STFPR/L-11 STGC...11 A...STFC.11
TCGT 110204	
TCGT 110208	
TCGT 16T302	STGC...16 A...STFC.16
TCGT 16T304	
TCGT 16T308	
TCGT 16T312	

ISO Standard	Type	Grade
N	Positive	PCD
		CVD

Order example: TCGT 090202 **PCD** or
TCGT 090202 **CVD**

Positive 60° - TCGT- GS

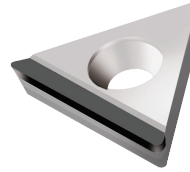
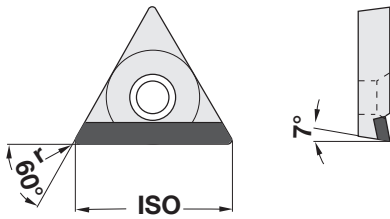

Ordering Code	Toolholder
TCGT 090202-GS	STGC...09 A...STFC.09
TCGT 090204-GS	
TCGT 090208-GS	
TCGT 110202-GS	E10M STFPR/L-11 STGC...11 A...STFC.11
TCGT 110204-GS	
TCGT 110208-GS	
TCGT 110212-GS	
TCGT 16T302-GS	STGC...16
TCGT 16T304-GS	
TCGT 16T308-GS	
TCGT 16T312-GS	

ISO Standard	Type	Grade
N	Positive	PCD
		CVD

Order example: TCGT 110208-GS **PCD** or
TCGT 110208-GS **CVD**

TCGW 60° - Single cutting edges

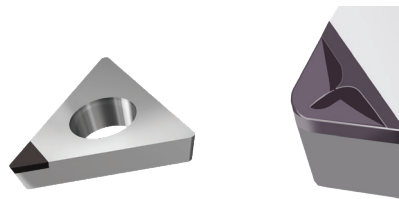
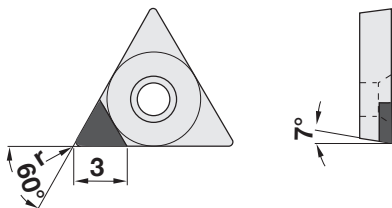

Neutral

Chip Breaker

Ordering Code	Toolholder
*TCGW 090201	STGC...09 A...STFC.09
TCGW 090202	
TCGW 090204	
TCGW 090208	
*TCGW 110201	STGC...11 A...STFC.11
TCGW 110202	
TCGW 110204	
TCGW 110208	
TCGW 16T302	STGC...16
TCGW 16T304	
TCGW 16T308	
TCGW 16T312	

ISO Standard	Type	Grade
N	Neutral	PCD
	F - Chip Breaker	
	R - Chip Breaker	
	Neutral	CVD
	F - Chip Breaker	
	R - Chip Breaker	

F - Finishing R - Roughing

Order example: TCGW 090208 **N PCD** or
TCGW 090208 **F CVD**

* Available only in **Neutral PCD/CVD** grade

TCGW 60°-GS

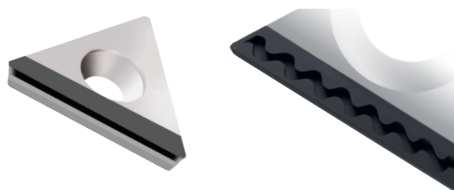
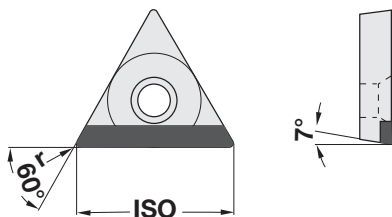

Neutral

Chip Breaker

Ordering Code	Toolholder
TCGW 090202-GS	STGC...09 A...STFC.09
TCGW 090204-GS	
TCGW 090208-GS	
TCGW 110202-GS	STGC...11 A...STFC.11
TCGW 110204-GS	
TCGW 110208-GS	
TCGW 110212-GS	
TCGW 16T302-GS	STGC...16
TCGW 16T304-GS	
TCGW 16T308-GS	
TCGW 16T312-GS	

ISO Standard	Type	Grade
N	Neutral	PCD
	F - Chip Breaker	
	R - Chip Breaker	
	Neutral	CVD
	F - Chip Breaker	
	R - Chip Breaker	

F - Finishing R - Roughing

Order example: TCGW 110212-GS **F PCD** or
TCGW 110212-GS **F CVD**

TPGW 60°-Single cutting edge

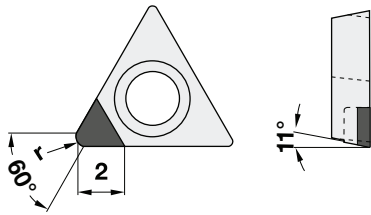

Ordering Code	Toolholder
*TPGW 06T101	E06H STXPR/L 06
TPGW 06T102	
TPGW 06T104	

Order example: TPGW 06T101 **N CVD**
 * Available only in **Neutral CVD** grade

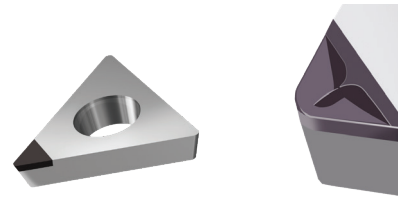

Neutral

Chip Breaker

ISO Standard	Type	Grade
N	Neutral	CVD
	F - Chip Breaker	
	R - Chip Breaker	

F - Finishing R - Roughing

Positive 35° VCGT-Single cutting edge

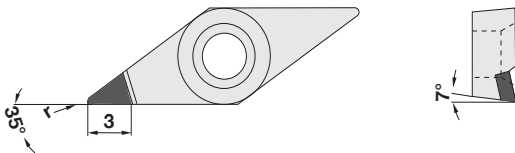

Ordering Code	Toolholder
VCGT 070201	SVJC./ SVVCN...07
VCGT 070202	
VCGT 070204	
VCGT 070208	
VCGT 110301	SVJC./SVVCN...11
VCGT 110302	
VCGT 110304	
VCGT 110308	
VCGT 160401	SVJC./SVHC./ SVVCN...16 A...SVJC.16
VCGT 160402	
VCGT 160404	
VCGT 160408	
VCGT 160412	

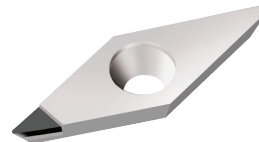

ISO Standard	Type	Grade
N	Positive	PCD CVD

Order example: VCGT 070208 **PCD** or
 VCGT 070208 **CVD**

VCGW 35°-Single cutting edge

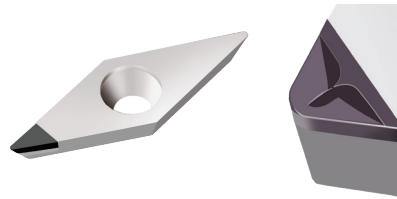
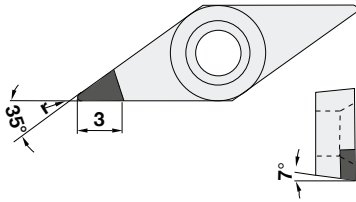

Neutral

Chip Breaker

Ordering Code	Toolholder
*VCGW 070201	SVJC./ SVVCN...07
VCGW 070202	
VCGW 070204	
VCGW 070208	
*VCGW 110301	SVJC./SVVCN...11
VCGW 110302	
VCGW 110304	
VCGW 110308	
*VCGW 160401	SVJC./SVHC./ SVVCN...16 A...SVJC.16
VCGW 160402	
VCGW 160404	
VCGW 160408	
VCGW 160412	

ISO Standard	Type	Grade
N	Neutral	PCD
	F - Chip Breaker	
	R - Chip Breaker	
	Neutral	CVD
	F - Chip Breaker	
	R - Chip Breaker	

F - Finishing R - Roughing

Order example: VCGW 070208 **N PCD** or
VCGW 070208 **F CVD**

* Available only in **Neutral PCD/CVD** grade

WCGW 80°-three cutting edges

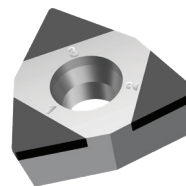
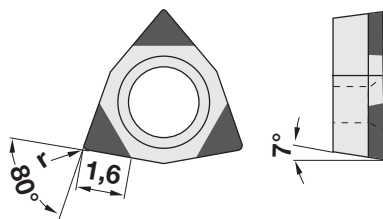

Ordering Code	Toolholder
WCGW 020101	E...SWUC. 02
WCGW 020102	
WCGW 020104	

ISO Standard	Type	Grade
N	Neutral	CVD

Order example: WCGW 020101 **CVD**

PCBN

Neutral 80° - CCGW – two cutting edges

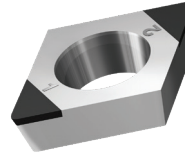
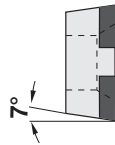
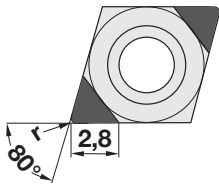

Ordering Code	Toolholder
*CCGW 060201	SCLC...06 A/E...SCLC.06
CCGW 060202	
CCGW 060204	
CCGW 060208	
*CCGW 09T301	SCLC...09 A/E...SCLC.09
CCGW 09T302	
CCGW 09T304	
CCGW 09T308	

ISO Standard	Coated	Grade
CP25 CP45		CBN
CK65 CK85		
CH25 CH45 CH65 CH85	✓	

Order example: CCGW 060201 **CH65 CBN** or
CCGW 09T302 **CK85 CBN**

* Available only in **CH25** and **CK65** grade

Wiper

Ordering Code	Toolholder
*CCGW 09T302-W	SCLC...09 A...SCLC.09
CCGW 09T304-W	
CCGW 09T308-W	

Order example: CCGW 09T302-W **CH65 CBN** or
CCGW 09T308-W **CK85 CBN**

* Available only in **CP25, CP45, CK65**
and **CK85** grade

Neutral 80° - CDGW – two cutting edges

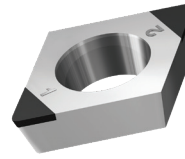
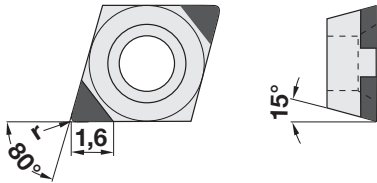

Ordering Code	Toolholder
CDGW 040101	E...SCLD.04
CDGW 040102	
CDGW 040104	

ISO Standard	Coated	Grade
CH65	✓	CBN

Order example: CDGW 040101 **CH65 CBN** or
CDGW 040104 **CH65 CBN**

Neutral 80° - CNGA – two cutting edges

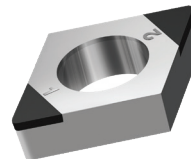
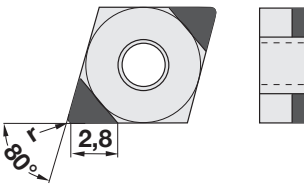

Ordering Code	Toolholder
CNGA 120402	DCLN..12 A...PCLN.12
CNGA 120404	
CNGA 120408	
CNGA 120412	

ISO Standard	Coated	Grade
CP25 CP45		CBN
CK65 CK85		
CH25 CH45 CH65 CH85	✓	

Order example: CNGA 120402 **CH65 CBN** or
CNGA 120412 **CK85 CBN**

Wiper

Ordering Code	Toolholder
CNGA 120404-W	DCLN..12 A...PCLN.12
CNGA 120408-W	

Order example: CNGA 120404 -**W CH65 CBN** or
CNGA 120408 -**W CK85 CBN**

Neutral 55° - DCGW – two cutting edges

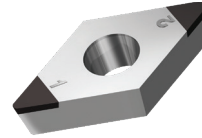
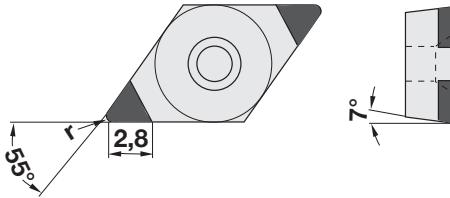

Ordering Code	Toolholder
*DCGW 070201	SDJC../ SDNCN..07 A...SDUC../ A/E...SDQC..07
DCGW 070202	
DCGW 070204	
DCGW 070208	
*DCGW 11T301	SDJC../ SDNCN..07 A...SDUC../ A/E...SDQC..07
DCGW 11T302	
DCGW 11T304	
DCGW 11T308	

ISO Standard	Coated	Grade
CP25 CP45		CBN
CK65 CK85		
CH25 CH45 CH65 CH85	✓	

Order example: DCGW 070204 **CH65 CBN** or
DCGW 11T308 **CK85 CBN**

* Available only in **CH25** and **CK65** grade

Wiper

Ordering Code	Toolholder
DCGW 11T304-W	SDJC...11 A...SDUC
DCGW 11T308-W	

Order example: DCGW 11T304 -W **CH65 CBN** or
DCGW 11T308 -W **CK85 CBN**

Neutral 55° - DNGA – two cutting edges

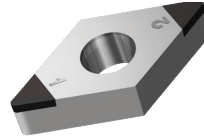
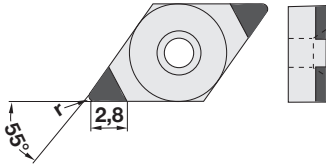

Ordering Code	Toolholder
*DNGA 150401	DDJN..15(04)
DNGA 150402	
DNGA 150404	
DNGA 150408	
DNGA 150412	

Order example: DNGA 150404 **CH65 CBN** or DNGA 150408 **CK85 CBN**

* Available only in **CH25** and **CK65** grade

ISO Standard	Coated	Grade
CP25 CP45		CBN
CK65 CK85		
CH25 CH45 CH65 CH85	✓	

Wiper

Ordering Code	Toolholder
DNGA 150404-W	DDJN..15(04)
DNGA 150408-W	

Order example: DNGA 150404-**W CH65 CBN** or DNGA 150408-**W CK85 CBN**

Neutral RCGW

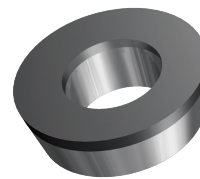

Ordering Code	Toolholder
RCGW 0602 M0-FF	SRDCN./ SRGC...06 E...SRLC.06
RCGW 0803 M0-FF	SRDCN./ SRGC...08 E...SRLC.08
RCGW 1003 M0-FF	SRDCN./ SRGC...1003 E... SRLC.06
RCGW 10T3 M0-FF	SRDCN./SRGC... 10T3
RCGW 1204 M0-FF	SRDCN./ SRGC...12

ISO Standard	Coated	Grade
CK65		CBN
CH65	✓	

Order example: RCGW 0602 M0-FF **CH65 CBN** or RCGW 1204 M0-FF **CK65 CBN**

Neutral 60° - TCGW – three cutting edges

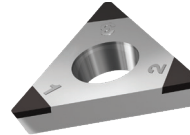
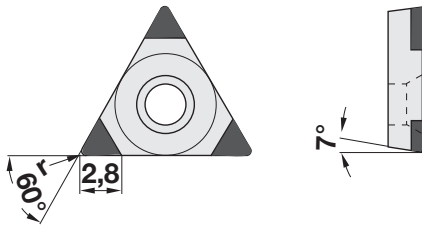

Ordering Code	Toolholder
*TCGW 090201	STGC...09
TCGW 090202	
TCGW 090204	
TCGW 090208	
*TCGW 110201	STGC...11
TCGW 110202	
TCGW 110204	
TCGW 110208	
TCGW 16T302	STGC...16
TCGW 16T304	
TCGW 16T308	

ISO Standard	Coated	Grade
CP25 CP45		CBN
CK65 CK85		
CH25 CH45 CH65 CH85	✓	

Order example: TCGW 090202 **CH65 CBN** or TCGW 16T308 **CK65 CBN**

* Available only in **CH25 CBN** grade

Neutral 60° - TNGA – three cutting edges

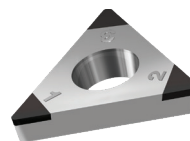
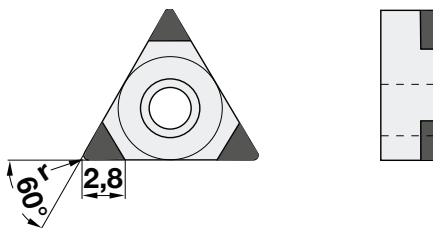

Ordering Code	Toolholder
TNGA 160402	MTJNR...16 MTENN...16
TNGA 160404	
TNGA 160408	
TNGA 160412	

ISO Standard	Coated	Grade
CP25 CP45		CBN
CK65 CK85		
CH25 CH45 CH65 CH85	✓	

Order example: TNGA 160402 **CH65 CBN** or TNGA 160408 **CK65 CBN**

Neutral 60° - TPGW – one cutting edge

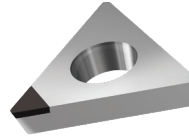
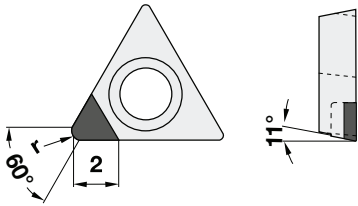

Ordering Code	Toolholder
TPGW 06T101	E06H STXPR/L 06
TPGW 06T102	
TPGW 06T104	

ISO Standard	Coated	Grade
CH65	✓	CBN

Order example: TPGW 06T101 **CH65 CBN** or
TPGW 06T104 **CH65 CBN**

Neutral 35° - VCGW – two cutting edges

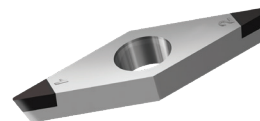
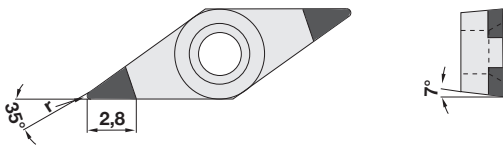

Ordering Code	Toolholder
*VCGW 070201	SVJC./SVHC./ SVVCN...07 E10..SVQC.07
VCGW 070202	
VCGW 070204	
*VCGW 110301	SVJC./SVHC./ SVVCN...11 E16..SVQC.11
VCGW 110302	
VCGW 110304	
VCGW 110308	
*VCGW 160401	SVJC./SVHC./ SVVCN...16 E25..SVQC.16
VCGW 160402	
VCGW 160404	
VCGW 160408	
VCGW 160412	

ISO Standard	Coated	Grade
CP25 CP45		CBN
CK65 CK85		
CH25 CH45 CH65 CH85	✓	

Order example: VCGW 070202 **CH65 CBN** or
VCGW 160408 **CH65 CBN**

* Available only in **CH25** and **CK65** grade

Neutral 35° - VNGA – two cutting edges

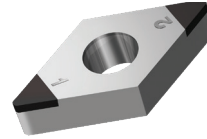
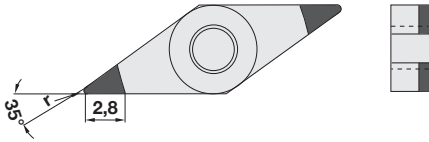

Ordering Code	Toolholder
VNGA 160402	MVJN./ MNVNN...16
VNGA 160404	
VNGA 160408	
VNGA 160412	

Order example: VNGA 160402 **CH65 CBN** or
VNGA 160408 **CH25 CBN**

ISO Standard	Coated	Grade
CP25 CP45		CBN
CK65 CK85		
CH25 CH45 CH65 CH85	✓	

Neutral 80° - WCGW – three cutting edges

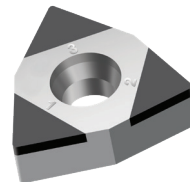
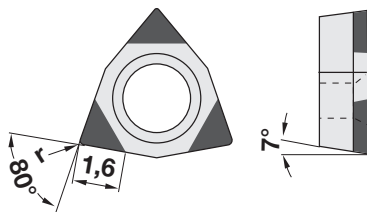

Ordering Code	Toolholder
WCGW 020101	E...SWUC. 02
WCGW 020102	
WCGW 020104	

Order example: WCGW 020101 **CH65 CBN** or
WCGW 020104 **CH65 CBN**

ISO Standard	Coated	Grade
CH65	✓	CBN

Neutral 80° - WNGA – three cutting edges

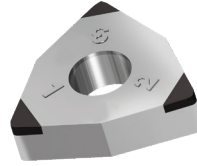
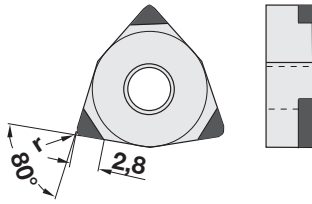

Ordering Code	Toolholder
WNGA 080402	DWLN./ MWLN...08
WNGA 080404	
WNGA 080408	
WNGA 080412	

Order example: WNGA 080402 **CH65 CBN** or
WNGA 080412 **CK65 CBN**

ISO Standard	Coated	Grade
CP25 CP45		CBN
CK65 CK85		
CH25 CH45 CH65 CH85	✓	

Wiper geometry

The wiper insert is designed with a short flat edge that is located where the straight edge meets the corner radius.

Wiper inserts are capable of turning at high feed rates - without losing the capability for generating good surface finishes or chip breaking ability.

Material type comparison

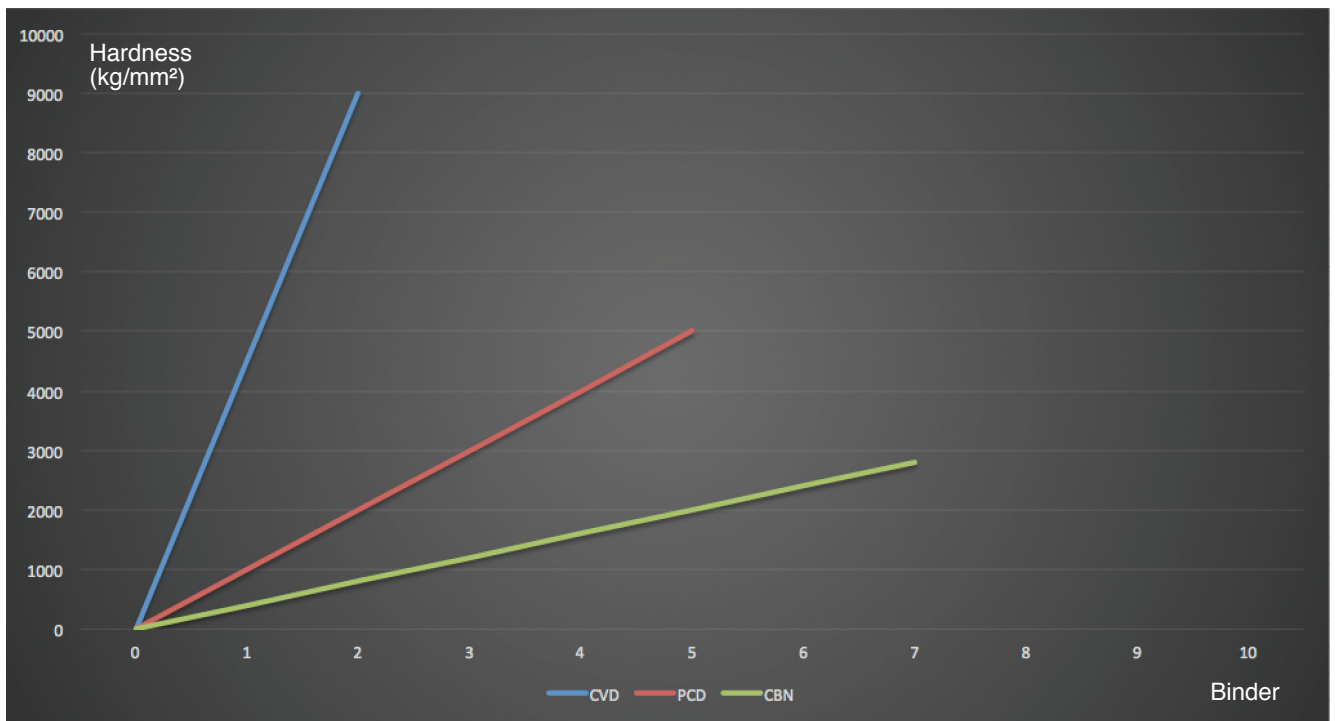

Technical information

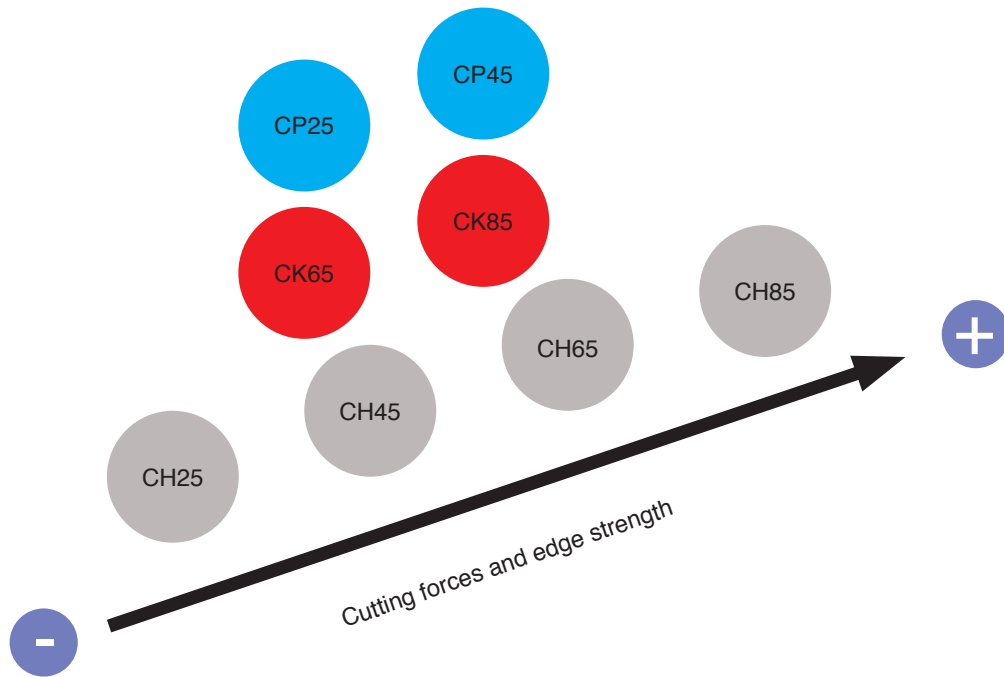

Working conditions and grade selection- CBN

Continuous





Medium interrupt

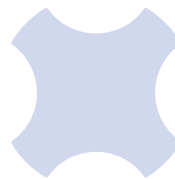

Heavy interrupt



ISO Standard			
CP25	✓	✓	
CP45		✓	✓
CK65	✓	✓	✓
CK85		✓	✓
CH25	✓		
CH45	✓	✓	✓
CH65	✓	✓	✓
CH85		✓	✓

Cutting Data- PCD/CVD inserts

N	r	Vc (m/min)			Ap (mm)			Feed (mm/rev)		
		N/P	F Finish	R Rough	N/P	F Finish	R Rough	N/P	F Finish	R Rough
Aluminum alloys Si < 1%	0.1	200-3000	200-3000	200-3000	0.01-2.80			0.01-0.05		
	0.2	200-3000	200-3000	200-3000	0.01-2.80	0.06-1.50	0.12-2.80	0.01-0.10	0.02-0.10	0.08-0.10
	0.4	200-3000	200-3000	200-3000	0.01-2.80	0.06-2.00	0.12-2.80	0.01-0.20	0.04-0.20	0.12-0.20
	0.8	200-3000	200-3000	200-3000	0.01-2.80	0.06-2.40	0.12-2.80	0.01-0.40	0.08-0.40	0.25-0.40
	1.2	200-3000	200-3000	200-3000	0.01-2.80	0.06-2.85	0.12-2.80	0.01-0.60	0.12-0.60	0.30-0.60
Aluminum Casting Alloys Si > 12%	0.1	150-2500	150-1800	150-2000	0.01-2.80			0.01-0.05		
	0.2	150-2500	150-1800	150-2000	0.01-2.80	0.06-1.50	0.12-2.80	0.01-0.10	0.02-0.10	0.08-0.10
	0.4	150-2500	150-1800	150-2000	0.01-2.80	0.06-2.00	0.12-2.80	0.01-0.20	0.04-0.20	0.12-0.20
	0.8	150-2500	150-1800	150-2000	0.01-2.80	0.06-2.40	0.12-2.80	0.01-0.40	0.08-0.40	0.25-0.40
	1.2	150-2500	150-1800	150-2000	0.01-2.80	0.06-2.85	0.12-2.80	0.01-0.60	0.12-0.60	0.30-0.60
Copper/ Brass/ Bronze	0.1	150-2500	150-2200	150-2800	0.01-2.80			0.01-0.05		
	0.2	150-2500	150-2200	150-2800	0.01-2.80	0.06-1.50	0.12-2.80	0.01-0.10	0.02-0.10	0.08-0.10
	0.4	150-2500	150-2200	150-2800	0.01-2.80	0.06-2.00	0.12-2.80	0.01-0.20	0.04-0.20	0.12-0.20
	0.8	150-2500	150-2200	150-2800	0.01-2.80	0.06-2.40	0.12-2.80	0.01-0.40	0.08-0.40	0.25-0.40
	1.2	150-2500	150-2200	150-2800	0.01-2.80	0.06-2.85	0.12-2.80	0.01-0.60	0.12-0.60	0.30-0.60
Ceramic/ Zirconium	0.1	150-2800	150-2200	150-2800	0.01-2.80			0.01-0.05		
	0.2	150-2800	150-2200	150-2800	0.01-2.80	0.06-1.50	0.12-2.80	0.01-0.10	0.02-0.10	0.08-0.10
	0.4	150-2800	150-2200	150-2800	0.01-2.80	0.06-2.00	0.12-2.80	0.01-0.20	0.04-0.20	0.12-0.20
	0.8	150-2800	150-2200	150-2800	0.01-2.80	0.06-2.40	0.12-2.80	0.01-0.40	0.08-0.40	0.25-0.40
	1.2	150-2800	150-2200	150-2800	0.01-2.80	0.06-2.85	0.12-2.80	0.01-0.60	0.12-0.60	0.30-0.60
Glass, Carbon fiber reinforced, Graphite	0.1	200-3000	150-2200	200-3000	0.01-2.80			0.01-0.05		
	0.2	200-3000	150-2200	200-3000	0.01-2.80	0.06-1.50	0.12-2.80	0.01-0.10	0.02-0.10	0.08-0.10
	0.4	200-3000	150-2200	200-3000	0.01-2.80	0.06-2.00	0.12-2.80	0.01-0.20	0.04-0.20	0.12-0.20
	0.8	200-3000	150-2200	200-3000	0.01-2.80	0.06-2.40	0.12-2.80	0.01-0.40	0.08-0.40	0.25-0.40
	1.2	200-3000	150-2200	200-3000	0.01-2.80	0.06-2.85	0.12-2.80	0.01-0.60	0.12-0.60	0.30-0.60

N/P- Neutral/Positive
 F - Finishing Chip Breaker
 R - Roughing Chip Breaker
 r - Corner Radius

Cutting Data - CBN inserts

	Grades →	CP25			CP45		
ISO	Material	Vc (m/min)	Ap (mm)	Feed (mm/rev)	Vc (m/min)	Ap (mm)	Feed (mm/rev)
P	Sintered steel	200-400	0.01-2.50	0.01-0.30	180-300	0.01-2.00	0.01-0.30

	Grades →	CK65			CK85		
ISO	Material	Vc (m/min)	Ap (mm)	Feed (mm/rev)	Vc (m/min)	Ap (mm)	Feed (mm/rev)
K	Grey Cast Iron	350-2000	0.01-2.80	0.01-0.35	350-1400	0.01-2.80	0.01-0.35
	Ductile graphite iron	250-1200	0.01-2.80	0.01-0.35	200-1000	0.01-2.80	0.01-0.35
	Chilled cast iron	80-200	0.01-2.50	0.01-0.30	80-180	0.01-2.50	0.01-0.30
	Sintered steel	200-400	0.01-2.50	0.01-0.30			
	Ni-Co-Fe base alloy	80-350	0.01-0.50	0.01-0.30			
	Stellite	80-140	0.01-2.50	0.06-0.25			
	Titanium	80-240	0.01-0.50	0.01-0.30			

	Grades →	CH25			CH45			CH65			CH85		
ISO	Material	Vc (m/min)	Ap (mm)	Feed (mm/rev)	Vc (m/min)	Ap (mm)	Feed (mm/rev)	Vc (m/min)	Ap (mm)	Feed (mm/rev)	Vc (m/min)	Ap (mm)	Feed (mm/rev)
H	> 45 HRc	100-400	0.01-0.50	0.01-0.25	100-300	0.01-0.80	0.01-0.40	80-180	0.01-0.30	0.01-0.15			
	> 68 HRc	80-240	0.01-2.50	0.01-0.25	60-220	0.01-1.50	0.01-0.25	60-200	0.01-0.50	0.01-0.25	60-180	0.01-0.30	0.01-0.20
	> 72 HRc	60-220	0.01-0.60	0.01-0.20	60-200	0.01-0.60	0.01-0.25	60-200	0.01-0.60	0.01-0.25	50-140	0.02-0.25	0.01-0.18
	Cold worked and hot forming tool steel	80-220	0.01-0.50	0.01-0.20	80-210	0.01-0.40	0.01-0.25				60-140	0.01-0.20	0.01-0.15
	Hard/soft machining	80-300	0.01-1.50	0.01-0.30	80-300	0.01-1.50	0.01-0.30	80-300	0.01-1.50	0.01-0.30			
	Sintered steel hardened	80-240	0.01-2.50	0.01-0.30	80-220	0.01-2.00	0.01-0.30						

Case Studies

Tool life PCD vs. CVD

Before:	PCD
Insert:	DCGT 070204 PCD
Vc:	380m/min
f:	0,12mm/rev
time/hole:	6 sec
tool life:	7 days
After:	CVD
Insert:	DCGW 070204 N CVD
Vc:	510m/min
f:	0,16mm/rev
time/hole:	4 sec
tool life:	14 days

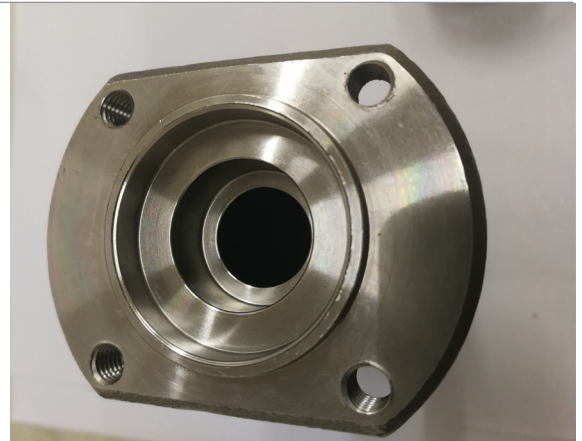

Benefits Carmex CVD against PCD

- 4 x higher tool life time
- Much better surfaces
- Much better tolerances
- Turning process is much cheaper
- Roughing and finishing possible
- Boring smallest holes are possible
- approx. 60-70% faster as grinding
- Drilling carbide is possible



Machining Inconel

Material:	Inconel 718
Work piece:	Shaft (1080mm)
CBN	VCGW 160408
Vc:	200m/min
ap:	0,15mm
f:	0,12
Ra:	0,11
Life time carbide:	4 min.
Life time CBN:	16 min.
Size accuracy:	+/-0,03

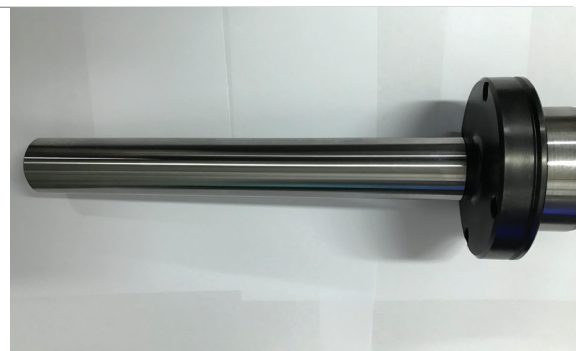

Carbide shank turning toolholder

High performance Carbide Shank, turning toolholders for internal machining from 6 mm (.236") minimum diameter and larger.

- Unique Carbide type for high rigidity
- Cylindrical shank
- Internal coolant supply to the cutting edge
- Screw clamping design
- Can be used also for standard ISO turn inserts

Boring bar, SWUBR/L type Lead angle $k=3^{\circ}$

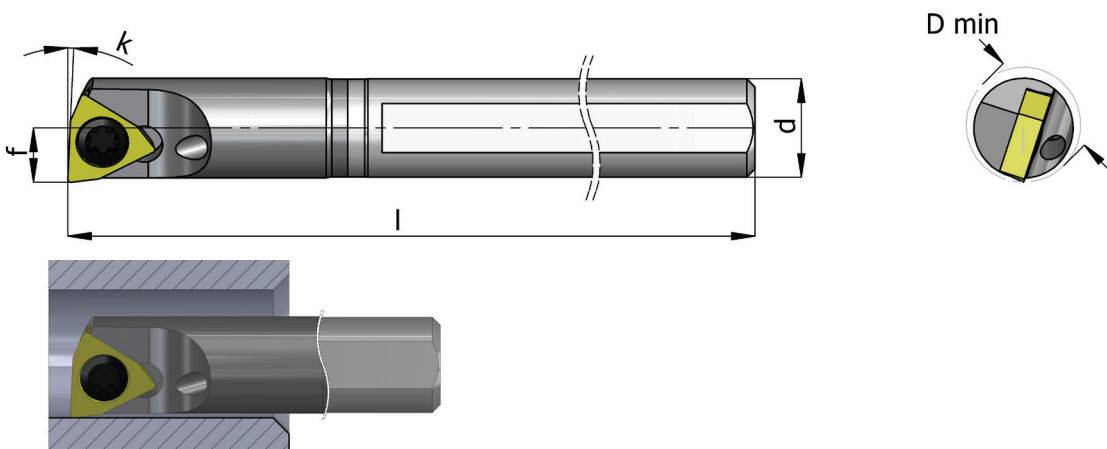

Metric holders

Ordering Code	R. Hand L. Hand	d	Min Bore Dia	l	f	k	Insert Screw	Torx Key	insert
E06H SWUBR-06	R	6	6.5	100	3.2	3°	S06	K06	WBMT 06 01 02R
E06H SWUBL-06	L	6	6.5	100	3.2	3°	S06	K06	WBMT 06 01 02L
E08K SWUBR-06	R	8	8.6	125	4.2	3°	S06	K06	WBMT 06 01 02R
E08K SWUBL-06	L	8	8.6	125	4.2	3°	S06	K06	WBMT 06 01 02L
E10M SWUBR-06	R	10	11.0	150	5.5	3°	S06	K06	WBMT 06 01 02R
E10M SWUBL-06	L	10	11.0	150	5.5	3°	S06	K06	WBMT 06 01 02L

Dimensions- mm

Inch holders

Ordering Code	R. Hand L. Hand	d	Min Bore Dia	l	f	k	Insert Screw	Torx Key	insert
E-SWUBR 4-5	R	1/4	.276	4	.134	3°	S06	K06	WBMT 06 01 02R
E-SWUBR 5-5	R	5/16	.331	5	.165	3°	S06	K06	WBMT 06 01 02R
E-SWUBR 6-5	R	3/8	.413	6	.210	3°	S06	K06	WBMT 06 01 02R

Dimensions- inch

Boring bar, SCLCR/L type Lead angle $k=5^{\circ}$

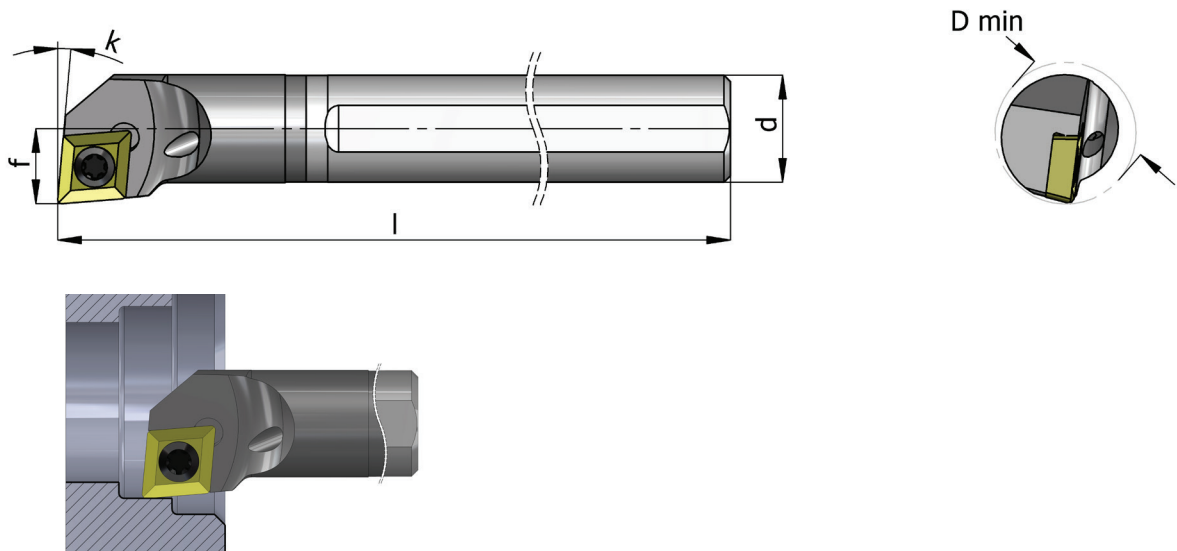

Metric holders

Ordering Code	R. Hand L. Hand	d	Min Bore Dia	l	f	k	Insert Screw	Torx Key	insert
E08K SCLCR-06	R	8	10.0	125	4.9	5°	S09	K07	CCMT 06 02 04
E08K SCLCL-06	L	8	10.0	125	4.9	5°	S09	K07	CCMT 06 02 04
E10M SCLCR-06	R	10	14.0	150	6.9	5°	S09	K07	CCMT 06 02 04
E10M SCLCL-06	L	10	14.0	150	6.9	5°	S09	K07	CCMT 06 02 04
E12P SCLCR-06	R	12	16.0	170	8.9	5°	S09	K07	CCMT 06 02 04
E12P SCLCL-06	L	12	16.0	170	8.9	5°	S09	K07	CCMT 06 02 04
E16R SCLCR-06	R	16	20.0	200	10.9	5°	S09	K07	CCMT 06 02 04
E16R SCLCL-06	L	16	20.0	200	10.9	5°	S09	K07	CCMT 06 02 04
E16R SCLCR-09	R	16	20.0	200	10.9	5°	S20	K22	CCMT 09 T3 08
E16R SCLCL-09	L	16	20.0	200	10.9	5°	S20	K22	CCMT 09 T3 08

Dimensions- mm

Inch holders

Ordering Code	R. Hand L. Hand	d	Min Bore Dia	l	f	k	Insert Screw	Torx Key	insert
E-SCLCR 5-2	R	5/16	.394	5	.193	5°	S09	K07	CCMT 06 02 04
E-SCLCR 6-2	R	3/8	.461	6	.250	5°	S09	K07	CCMT 06 02 04
E-SCLCR 8-2	R	1/2	.622	7	.353	5°	S09	K07	CCMT 06 02 04
E-SCLCR 10-3	R	5/8	.787	8	.429	5°	S20	K22	CCMT 09 T3 08
E-SCLCR 12-3	R	3/4	.985	10	.500	5°	S20	K22	CCMT 09 T3 08

Dimensions- inch

Boring bar, SDUCR/L type Lead angle $k=3^{\circ}$

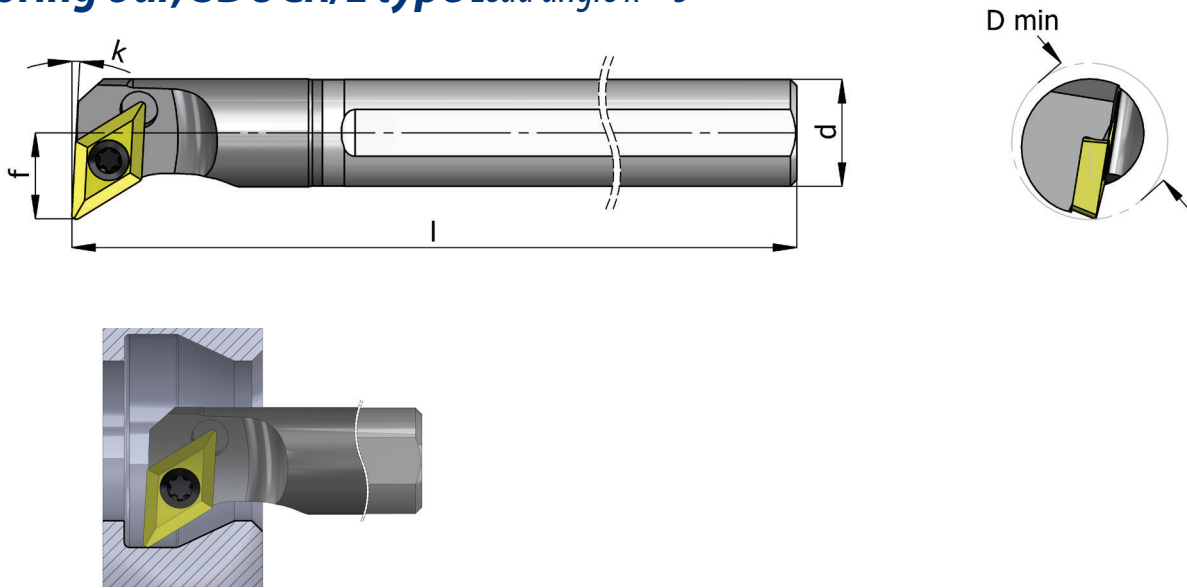

Metric holders

Ordering Code	R. Hand L. Hand	d	Min Bore Dia	l	f	k	Insert Screw	Torx Key	insert
E10M SDUCR-07	R	10	14.0	150	7.9	3°	S09	K07	DCMT 07 02 04
E10M SDUCL-07	L	10	14.0	150	7.9	3°	S09	K07	DCMT 07 02 04
E12P SDUCR-07	R	12	16.0	170	8.9	3°	S09	K07	DCMT 07 02 04
E12P SDUCL-07	L	12	16.0	170	8.9	3°	S09	K07	DCMT 07 02 04
E16R SDUCR-07	R	16	20.0	200	10.9	3°	S09	K07	DCMT 07 02 04
E16R SDUCL-07	L	16	20.0	200	10.9	3°	S09	K07	DCMT 07 02 04

Dimensions- mm

Inch holders

Ordering Code	R. Hand L. Hand	d	Min Bore Dia	l	f	k	Insert Screw	Torx Key	insert
E-SDUCR 6-2	R	3/8	.563	6	.353	3°	S09	K07	DCMT 07 02 04
E-SDUCR 8-2	R	1/2	.630	7	.353	3°	S09	K07	DCMT 07 02 04
E-SDUCR 10-2	R	5/8	.787	8	.431	3°	S09	K07	DCMT 07 02 04
E-SDUCR 12-3	R	4/3	.985	10	.500	3°	S20	K22	DCMT 11T 304

Dimensions- inch

Boring bar, STFPR/L type Lead angle $k=1^\circ$

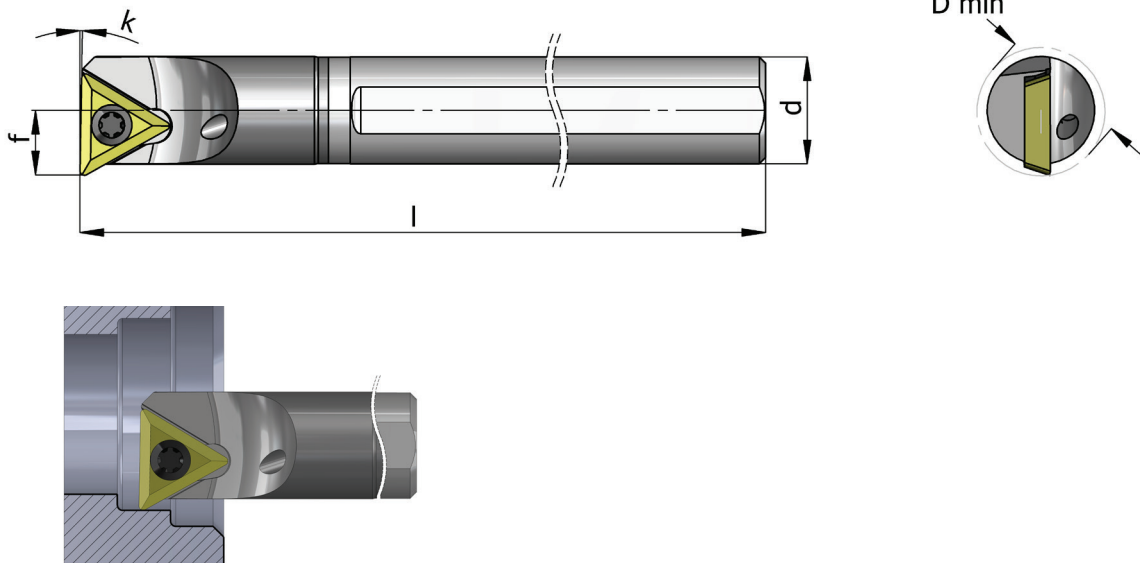

Metric holders

Ordering Code	R. Hand L. Hand	d	Min Bore Dia	l	f	k	Insert Screw	Torx Key	insert
E10M STFPR-11	R	10	11.0	150	5.9	1°	S18	K07	TPGB 11 03 04
E10M STFPL-11	L	10	11.0	150	5.9	1°	S18	K07	TPGB 11 03 04
E12P STFPR-11	R	12	14.0	170	6.9	1°	S18	K07	TPGB 11 03 04
E12P STFPL-11	L	12	14.0	170	6.9	1°	S18	K07	TPGB 11 03 04

Dimensions- mm

Inch holders

Ordering Code	R. Hand L. Hand	d	Min Bore Dia	l	f	k	Insert Screw	Torx Key	insert
E-STFPR 6-2	R	3/8	.449	6	.217	1°	S18	K07	TPGB 11 03 04
E-STFPR 8-2	R	1/2	.555	7	.285	1°	S18	K07	TPGB 11 03 04
E-STFPR 10-2	R	5/8	.689	8	.343	1°	S18	K07	TPGB 11 03 04

Dimensions- inch

Tiny Tools with diamond cutting edge

Carmex wide range of Tiny Tools now includes a CBN and CVD tipped bars, for boring and profiling.

- CBN tools are used for hard turning of grey cast iron; steels up to 72 HRC, Sintered carbide, as well as Nickel based super alloys.
- The CVD-T (Thick film diamond) bars delivers various benefits when machining long-chipping aluminum and magnesium alloys, high-silica aluminum as well as of precious metal alloys, plastics with abrasive fillers, tungsten carbide and ceramic green compacts

Features:

- Internal through coolant to the cutting edge.
- Suitable for continuous or interrupted cut.
- Bore diameter 3.1 mm and larger.
- To use with the standard SIM toolholders



Product Identification

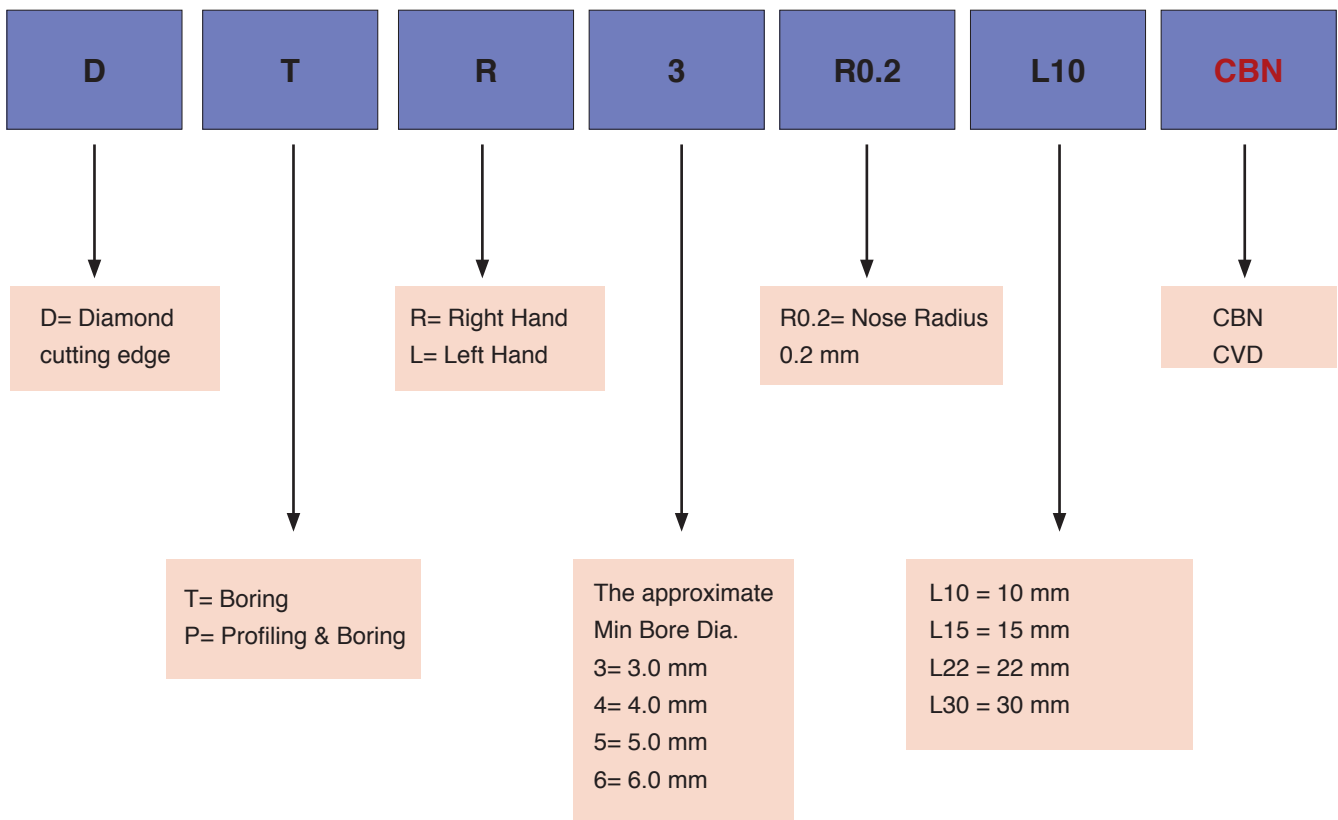

DTR Bars Boring

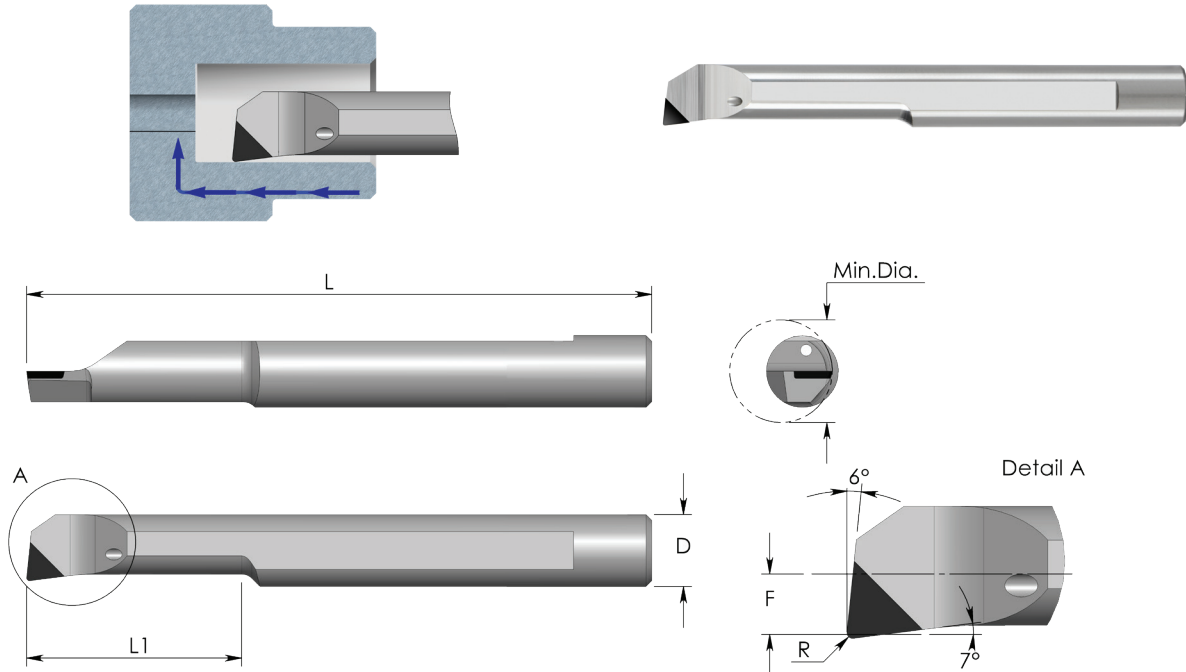

	P	M	K	N	S	H
CBN			•		•	≤ 72 HRc
CVD				•		

D	Ordering Code	L	L1	R	F	Min. Dia.	Holder
4.0	DTR 3 R0.2 L10	51	10	0.20	1.3	3.1	SIM...H4
	DTR 3 R0.2 L15	51	15	0.20	1.3	3.1	
4.0	DTR 4 R0.2 L10	51	10	0.20	1.7	4.1	SIM...H4
	DTR 4 R0.2 L15	51	15	0.20	1.7	4.1	
	DTR 4 R0.2 L22	51	22	0.20	1.7	4.1	
5.0	DTR 5 R0.2 L15	51	15	0.20	2.1	5.1	SIM...H5
	DTR 5 R0.2 L22	51	22	0.20	2.1	5.1	
6.0	DTR 6 R0.2 L15	51	15	0.20	2.8	6.1	SIM...H6
	DTR 6 R0.2 L22	51	22	0.20	2.8	6.1	
	DTR 6 R0.2 L30	58	30	0.20	2.8	6.1	

For L.H. bars specify DTL... instead of DTR...

Order example: DTR 5 R0.2 L15 CBN
DTR 5 R0.2 L15 CVD

DPR Bars Profiling and Boring

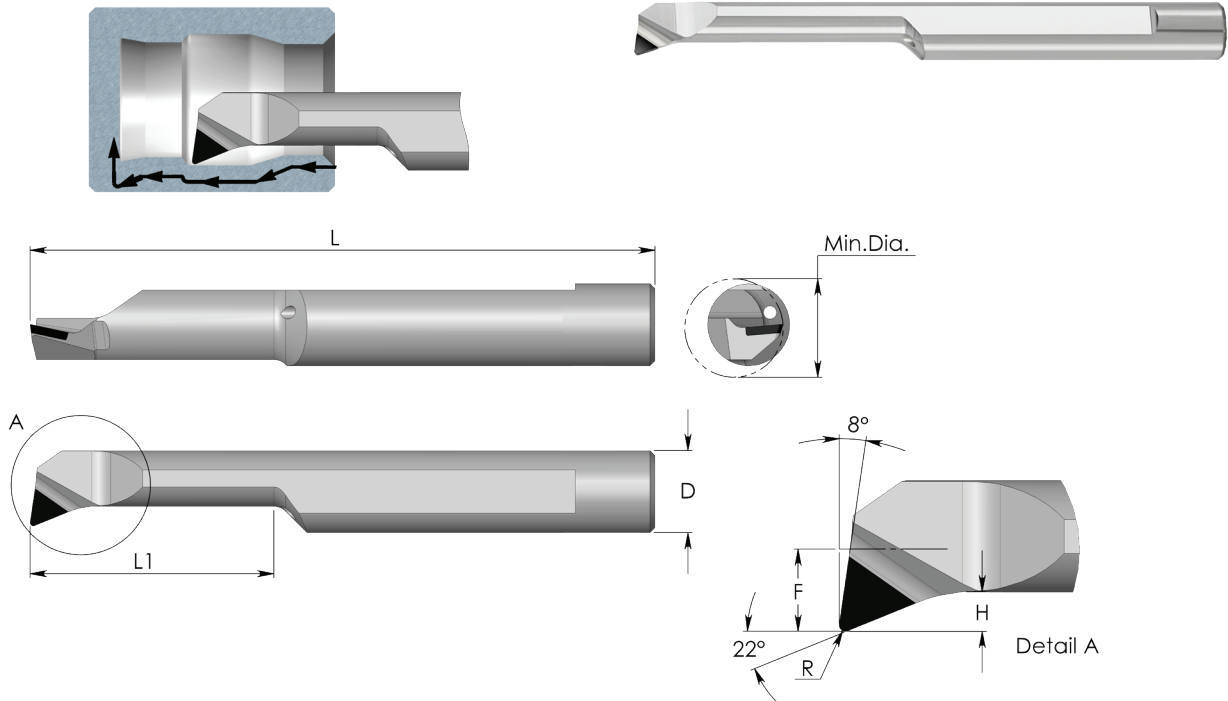

	P	M	K	N	S	H
CBN			•		•	≤ 72 HRc
CVD				•		

D	Ordering Code	L	L1	R	H	F	Min. Dia.	Holder
4.0	DPR 3 R0.2 L10	51	10	0.20	0.7	1.3	3.1	SIM...H4
	DPR 3 R0.2 L15	51	15	0.20	0.7	1.3	3.1	
4.0	DPR 4 R0.1 L10	51	10	0.10	0.8	1.7	4.1	SIM...H4
	DPR 4 R0.2 L10	51	10	0.20	0.8	1.7	4.1	
	DPR 4 R0.2 L15	51	15	0.20	0.8	1.7	4.1	
5.0	DPR 5 R0.2 L15	51	15	0.20	1.2	2.1	5.1	SIM...H5
	DPR 5 R0.2 L22	51	22	0.20	1.2	2.1	5.1	
6.0	DPR 6 R0.2 L15	51	15	0.20	1.4	2.8	6.1	SIM...H6
	DPR 6 R0.2 L22	51	22	0.20	1.4	2.8	6.1	
	DPR 6 R0.2 L30	76	30	0.20	1.4	2.8	6.1	

For L.H. bars specify DPL... instead of DPR...

Order example: DPR 5 R0.2 L15 CBN
DPR 5 R0.2 L15 CVD

Cutting Data

CBN

ISO Standard	Material	Cutting Speed Vc (m/min)	Feed Rate f (mm/rev)	Depth of Cut Ap (mm)
K	Cast Iron Nodular (GGG)	20-200	0.01-0.10	Ø3: 0.02-0.07 Ø4: 0.02-0.10 Ø5: 0.02-0.12 Ø6: 0.02-0.15
	Grey Cast Iron (GG)			
S	High Temperature/Super Alloys			
H	Hardened Steel 45-72 HRc Sintered carbide			

CVD

ISO Standard	Material	Cutting Speed Vc (m/min)	Feed Rate f (mm/rev)	Depth of Cut Ap (mm)
N	Aluminum Alloys	20-1500	0.01-0.15	Ø3: 0.05-0.80 Ø4: 0.05-0.90 Ø5: 0.05-1.10 Ø6: 0.05-1.20
	Aluminum Alloys up to 12%Si			
	Magnesium			
	Cooper/ Brass/Bronze			
	Graphite			
	Ceramic/Zirconium			
	Reinforced Plastics			
	GFRP- Glass Fiber Reinforced Polymer			

Diamond end mills

Product Identification: End mills/Ball nose

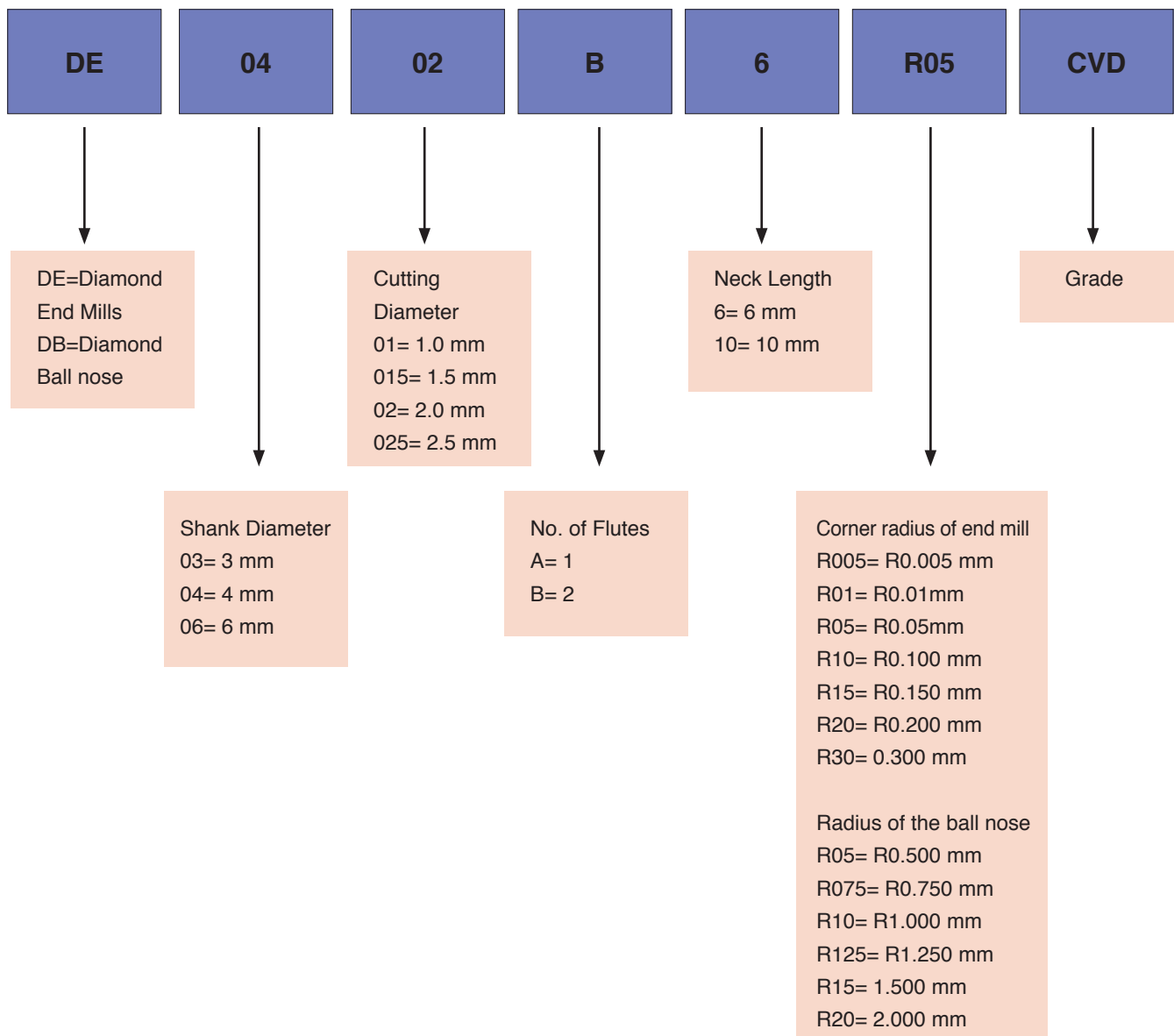

End mill - CVD

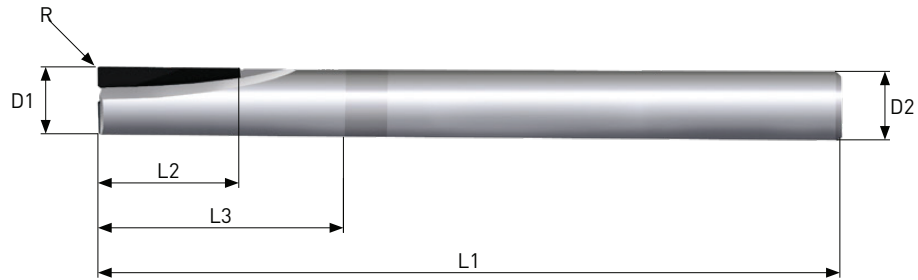

D1	Ordering Code	D2 (h5)	No of flutes	L2	L3	L1	R±4μm
1.0	DE0401 A4 R05	4	1	3.0	4.0	50	0.050
	DE0601 A5 R10	6	1	2.0	5.0	50	0.100
	DE0601 A10 R10	6	1	2.0	10.0	50	0.100
	DE0601 A20 R10	6	1	2.0	20.0	50	0.100
1.5	DE04015 B3 R005	4	2	2.0	3.0	38	0.005
	DE04015 B4 R05	4	2	3.0	4.0	50	0.050
	DE06015 B5 R15	6	2	2.0	5.0	50	0.150
	DE06015 B10 R15	6	2	2.0	10.0	50	0.150
	DE06015 B20 R15	6	2	2.0	20.0	50	0.150
2.0	DE0402 B3 R005	4	2	2.0	3.0	38	0.005
	DE0402 B6 R005	4	2	4.0	6.0	38	0.005
	DE0402 B6 R05	4	2	3.0	6.0	38	0.050
	DE0402 B5 R10	4	2	3.0	5.0	50	0.100
	DE0402 B8 R10	4	2	3.0	8.0	50	0.100
	DE0602 B5 R15	6	2	3.0	5.0	50	0.150
	DE0602 B10 R15	6	2	3.0	10.0	50	0.150
	DE0602 B20 R15	6	2	3.0	20.0	50	0.150
2.5	DE04025 B7 R005	4	2	5.0	7.0	38	0.005
	DE04025 B6 R10	4	2	4.0	6.0	50	0.100
	DE04025 B10 R10	4	2	4.0	10.0	50	0.100
3.0	DE0403 B5 R005	4	2	3.0	5.0	38	0.005
	DE0403 B9 R005	4	2	6.0	9.0	38	0.005
	DE0603 B8 R20	6	2	5.0	8.0	50	0.200
	DE0603 B8 R50	6	2	5.0	8.0	50	0.500
	DE0603 B12 R10	6	2	5.0	12.0	60	0.100
	DE0603 B10 R30	6	2	4.0	10.0	75	0.300
	DE0603 B15 R30	6	2	4.0	15.0	75	0.300
	DE0603 B20 R30	6	2	4.0	20.0	75	0.300
4.0	DE0404 B10 R01	4	2	6.0	10.0	38	0.010
	DE0604 B10 R10	6	2	5.0	10.0	60	0.100
	DE0604 B10 R30	6	2	5.0	10.0	60	0.300
	DE0604 B10 R50	6	2	5.0	10.0	60	0.500
	DE0604 B10 R10	6	2	5.0	16.0	65	0.100
	DE0604 B20 R30	6	2	5.0	20.0	75	0.300
	DE0604 B30 R30	6	2	5.0	30.0	75	0.300

Ball nose - CVD

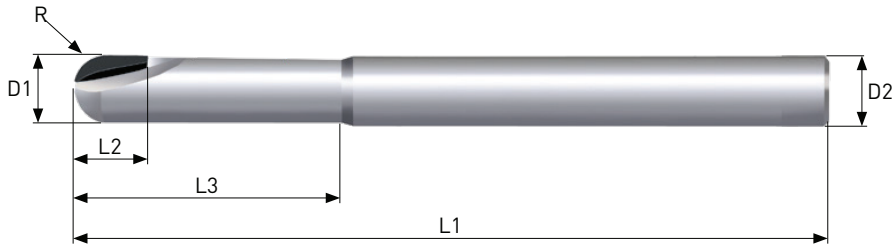

D1	Ordering Code	D2 (h5)	No of flutes	L2	L3	L1	R±4μm
1.0	DB0301 A4 R05	3	1	1.0	4.0	32	0.500
	DB0401 A4 R05	4	1	3.0	4.0	50	0.500
	DB0601 A5 R05	6	1	2.0	5.0	50	0.500
	DB0601 A10 R05	6	1	2.0	10.0	50	0.500
	DB0601 A20 R05	6	1	2.0	20.0	50	0.500
1.5	DB03015 B5 R075	3	2	2.0	5.0	32	0.750
	DB04015 B5 R075	4	2	3.0	5.0	50	0.750
	DB06015 B5 R075	6	2	2.0	5.0	50	0.750
	DB06015 B15 R075	6	2	2.0	15.0	50	0.750
	DB06015 B20 R075	6	2	2.0	20.0	50	0.750
2.0	DB0302 B5 R10	3	2	3.0	5.0	32	1.000
	DB0302 B8 R10	3	2	3.0	8.0	32	1.000
	DB0402 B5 R10	4	2	3.0	5.0	50	1.000
	DB0402 B8 R10	4	2	3.0	8.0	50	1.000
	DB0602 B5 R10	6	2	3.0	5.0	50	1.000
	DB0602 B15 R10	6	2	3.0	15.0	50	1.000
	DB0602 B20 R10	6	2	3.0	20.0	50	1.000
2.5	DB03025 B6 R125	3	2	3.0	6.0	32	1.250
	DB03025 B10 R125	3	2	3.0	10.0	32	1.250
	DB04025 B6 R125	4	2	3.0	6.0	50	1.250
	DB04025 B10 R125	4	2	3.0	10.0	50	1.250
3.0	DB0303 B6 R15	3	2	4.0	6.0	32	1.500
	DB0303 B9 R15	3	2	4.0	9.0	32	1.500
	DB0603 B8 R15	6	2	5.0	8.0	50	1.500
	DB0603 B12 R15	6	2	5.0	12.0	60	1.500
	DB0603 B10 R15	6	2	4.0	10.0	50	1.500
	DB0603 B15 R15	6	2	4.0	15.0	50	1.500
	DB0603 B20 R15	6	2	4.0	20.0	50	1.500
4.0	DB0404 B7 R20	4	2	5.0	7.0	38	2.000
	DB0404 B10 R20	4	2	5.0	10.0	38	2.000
	DB0604 B10 R20	6	2	5.0	10.0	60	2.000
	DB0604 B16 R20	6	2	5.0	16.0	65	2.000
	DB0604 B10 R20	6	2	5.0	10.0	75	2.000
	DB0604 B20 R20	6	2	5.0	20.0	75	2.000
	DB0604 B30 R20	6	2	5.0	30.0	75	2.000

Cutting Data – CVD end mills/ball nose

N	Vc (m/min)	Cutting Diameter Fz (mm/tooth)	
		Ø1-3	Ø4
Aluminum alloys Si < 1%	150-4000	0.007-0.05	0.02-0.15
Aluminum Casting Alloys Si > 12%	150-2000	0.007-0.05	0.02-0.15
Magnesium/Copper/Brass/	150-4000	0.007-0.05	0.02-0.15
Ti alloys	50-400	0.007-0.05	0.02-0.15
Graphite	150-3000	0.007-0.05	0.02-0.15
Glass fiber/ Carbon fiber composites	150-3000	0.007-0.05	0.02-0.15
Peek	150-2000	0.007-0.05	0.02-0.15
Thermoplastics, Duroplas- tics	150-4000	0.007-0.05	0.02-0.15
Ceramic/ Zirconium	75-300	0.007-0.05	0.02-0.15
Glass, Carbon fiber rein- forced, Graphite	150-3000	0.007-0.05	0.02-0.15



Hacharoshet St. 1, Maalot Industrial Zone 2101302, ISRAEL
Tel: (972) 4-9077400, Fax: (972) 4-9077440.
E-mail: info@carmex.com Website: www.carmex.com
Postal address: P.O. Box 404, Maalot 2101302, ISRAEL.